

VAC 1/2 E6 C MT

CLUB Tap Range Club Basin Taps Eco6 with Metal Heads Chrome



Specification

Product Type:	Bathroom taps
Main Construction Material:	Brass
Mount Type:	Deck
Handle Type:	Handwheel Handle
Connection Inlet:	1/2" BSP
Connection Outlet:	Aerator
Number of Tap Holes:	2
Valve/Cartridge Type:	1/2" Standard Valve
Plumbing System Requirements:	Suitable for all plumbing systems
Minimum Dynamic Pressure:	0.2 bar
Maximum Dynamic Pressure:	5.0 bar
Maximum Hot Water Temperature: °C	65
Maximum Static Pressure: (bar)	10
Flow Type:	Single Flow
Isolation Included:	No

Features:

- Supplied with metal handles
- Supplied with metal backnuts
- Product supplied with 2 x 3 litre per minute flow regulators which can be inserted into the threaded tail to reduce water consumption and increase water efficiency (Flow Regulator accurate +/- 10%)

Product Certifications:



For more products, visit our website:
<http://www.bristan.com>



Dimensions (measurements in mm)

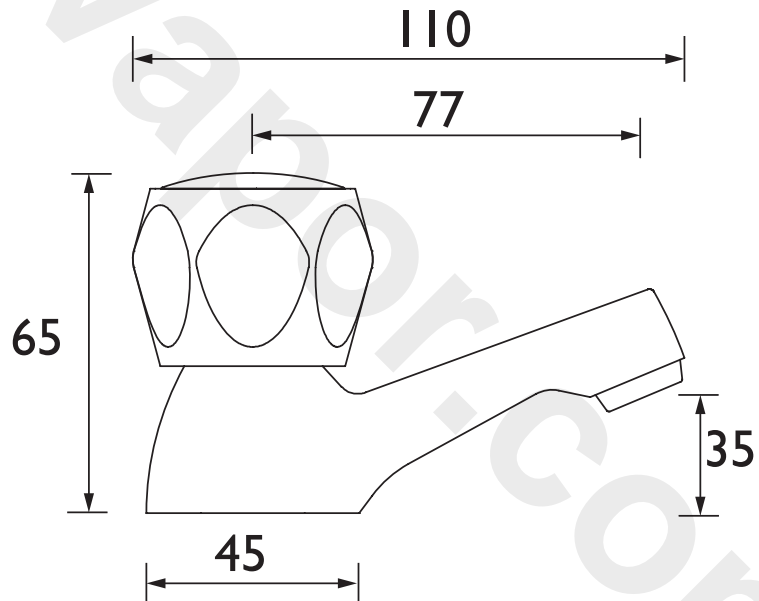

Flow Rates (l/min)

System Pressure (bar)	0.2	0.5	1	2	3	5
VAC 1/2 E6 C MT	6	6	6	6	6	6

TECHNICAL
DATA
SHEET



BRISTAN

D5